

BuzziBack

INSTALLATION MANUAL

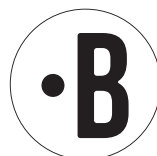
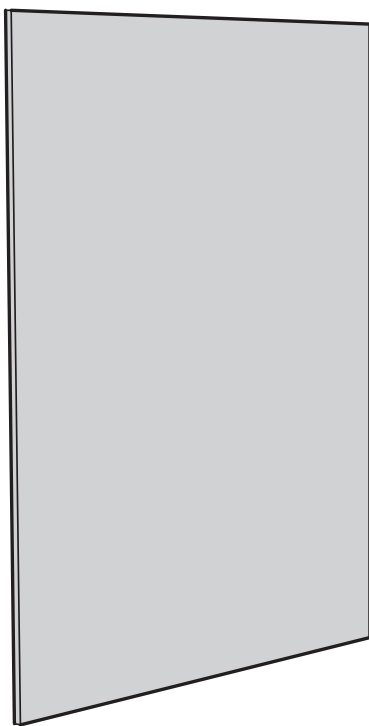

Note

Be sure wall surface is free of dirt, grease or any special paint finishes that could prevent the adhesive from adhering to wall surface.

Excluded

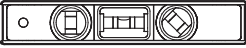

Included

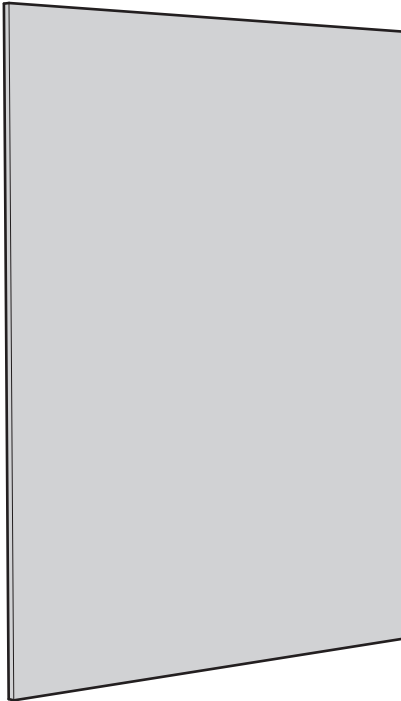

BuzziBack

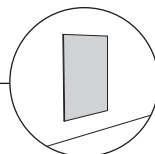

1 PERS. 

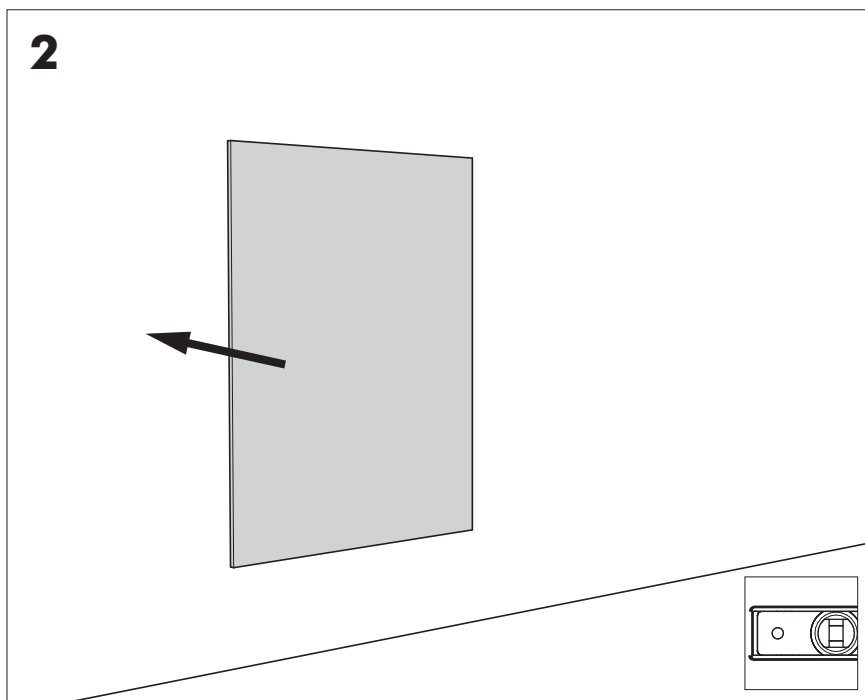
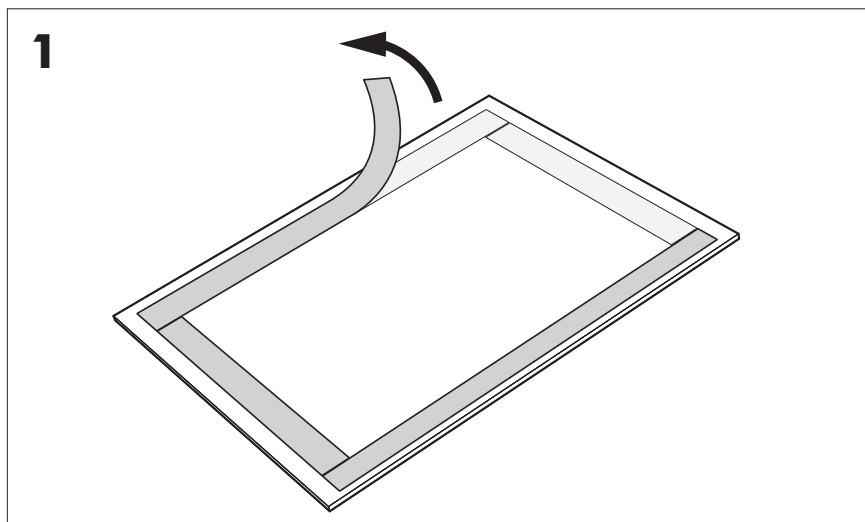

BuzziSpace
Groeningenlei 141
2550 Antwerp, Kontich
Belgium
☎ +32 (0)3 846 10 00
✉ info@buzzi.space
🌐 www.buzzi.space

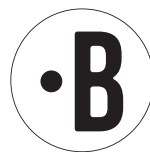

Doc nr.: A-0000001808/1
Last update: 06/06/2019