



---

# BuzziShade

## Standing 220-240V

### Product Specification Sheet

---

This document contains technical information about the BuzziShade Standing



[www.buzzi.space](http://www.buzzi.space)



## Standing lighting element in BuzziFelt









BuzziShade Standing offers decorative lighting and reduces external noise levels to a minimum.

BuzziShade is extremely versatile. The standing version is ideal to add in any waiting room, hotel lobby or even at home to create that perfect hideaway.

Designed by Stal Collectief

---

## General

-  Standing
-  BuzziFelt cover
-  Powder coated metal frame
-  Fabric power cord
-  Input Voltage: 220 - 240V
-  Input Frequency: 50/60Hz
-  Class: 1
-  Dry usage
-  Assembled

---

## Acoustics



Absorption



Mid Tones



High Tones

---

## Content

Configurations	3
Technical components	4
Fabrics	5
Dimensions	6
Acoustics	7

# Configurations

---

## BuzziShade Standing

- 🌲 BuzziFelt cover with lace  
Metal frame in black (RAL 9005), white (RAL 9010),  
alu (RAL 9006) or fluorescent orange (RAL 2005)  
Fabric power cord in black, red or fluorescent orange  
Black footswitch

- ✂ Height: 222 cm  
Diameter: Ø 69 cm - 144 cm

- 💡 E27 Fitting (Max. 60W)  
Excl. Bulb

- ⚖ 18 kg

- ⋯ Lace: black | white | fluorescent orange

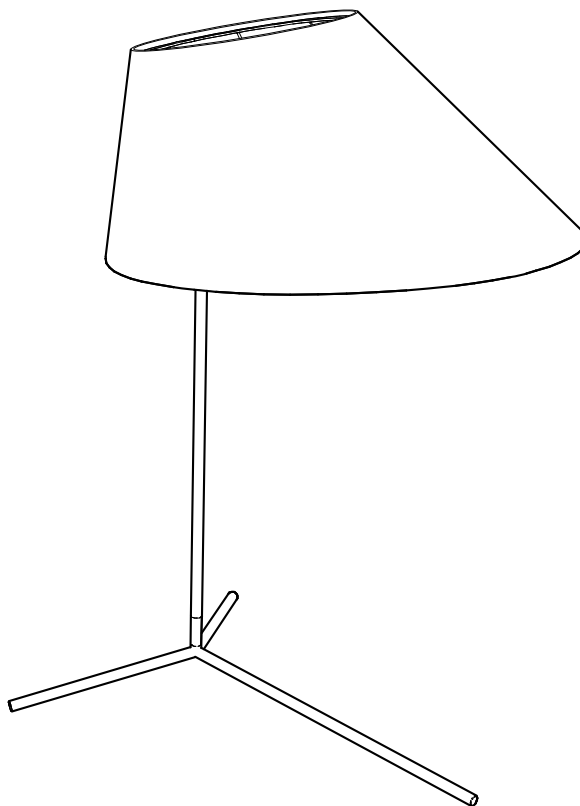

# Technical Components

---

## BuzziShade Standing

### Frame

Metal frame available in following colors:

Powder coated white		RAL 9010
Powder coated black		RAL 9005
Fluorescent orange		RAL 2005



### Fitting | Power cord

Black bakelite fitting E27 fitting  
Fabric power cord

Color frame	Color fitting	Color fabric power cord
black	black	black
white	white	red
fluorescent orange	black	fluorescent orange

Power cord has a length of 250 cm finished with a plug and footswitch.

### Power switch

Black footswitch

# Fabrics

---

## Felt

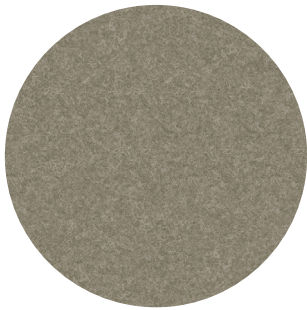

**Composition** 100% Recycled PE.T. Felt, latex backing

**Weight** 1.000 g/m2 | 29.49 oz/yd2

**Abrasion resistance** >7.000 Martindale

**Flammability** EU: EN 13501.1 + A1/2009 Class B-s1,d0

USA: ASTM E84 Class A certified

**Fastness to light** USA 5



---

## Lace

Lace black | white | fluorescent orange



# Dimensions

## BuzziShade Standing

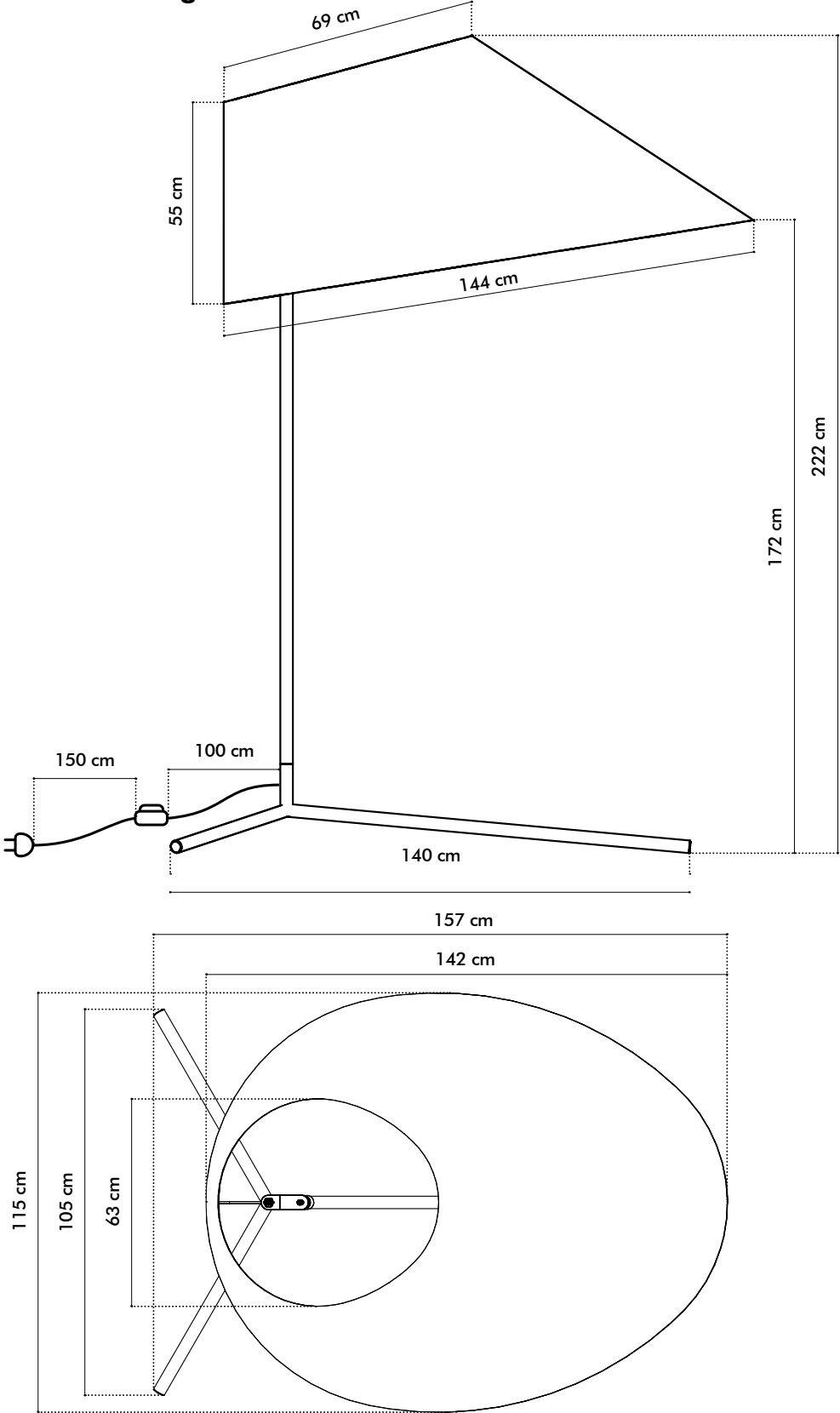

# Acoustics

## BuzziShade Standing

Equivalent sound absorption area in m<sup>2</sup> per object

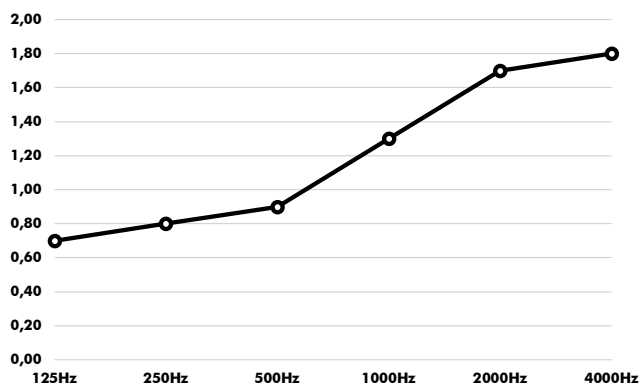

Hz	Shade Standing Aeq/m <sup>2</sup>
125	0.70
250	0.80
500	0.90
1000	1.30
2000	1.70
4000	1.80