BuzziBlinds Classic

Product Specification Sheet

This document contains technical information about the BuzziBlinds Classic



www.buzzi.space



Room divider

These rotating acoustic blinds take their inspiration from modernist architecture—more specifically from the exterior sunshades that can be found on modernist buildings designed by Oscar Niemeyer. The free-standing room divider is made up of a series of five rotating acoustic blinds. With a simple twist, the blinds can be opened or closed to varying degrees to create privacy or open-up a space. This gives individuals the opportunity to determine the level of privacy they may want or need at any given moment to concentrate on a specific task.

Design by Alain Gilles

General

📏 Small | Medium | Large

Baseplate: powder coated metal

🌲 Blinds: aluminium core
BuzziFelt cover

☁️ Dry use

🔑 Flat packed

Baseplate regular or curved

Baseplate color in black (RAL 9005) or white (RAL 9010)

⋮ Optional extra layer Fabric, Rough, Trevira CS+ | CS, Revive 1, Revive 2, Terra, Clara 2, Remix 2, Hero, Tonus 4, Memory 2 or Matrix

Bicolor (front & back different color)

Wheels (4pcs)

Acoustics



Attenuation



Diffusion



Absorption



Mid tones



High tones

Content

Configurations	3
Fabrics	4
Dimensions	9
Acoustics	10

Configurations

BuzziBlinds Classic

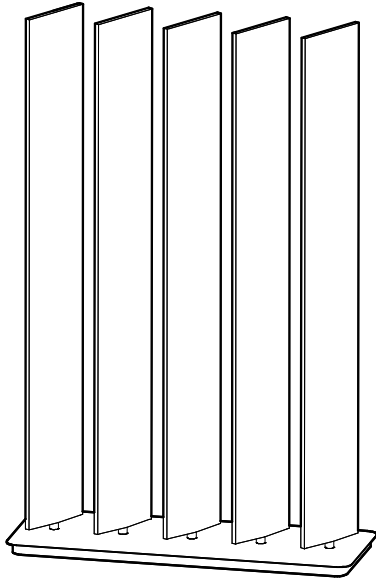

Regular

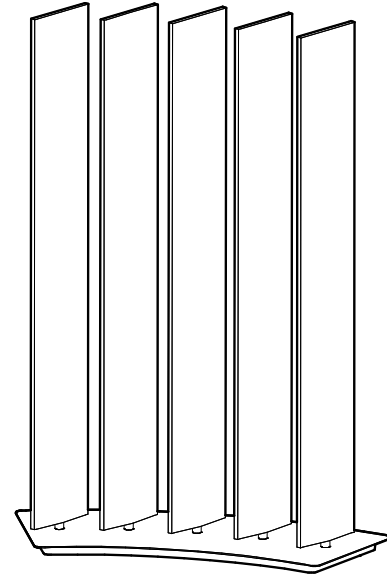

Curved

Small | Medium | Large

Baseplate: powder coated metal

Blinds: aluminium core
BuzziFelt cover

Baseplate regular

S: H 120 cm W 100 cm D 37 cm
H 47.24" W 39.37" D 14.57"

M: H 155 cm W 100 cm D 37 cm
H 61.02" W 39.37" D 14.57"

L: H 190 cm W 100 cm D 37 cm
H 74.80" W 39.37" D 14.57"

+ Wheels: + 3 cm | 1.18"

S: 19,2 kg | 42.33 lbs

M: 22,1 kg | 48.72 lbs

L: 25,4 kg | 56.00 lbs

+ Wheels: + 0,22 kg | 0.49 lbs

Baseplate regular or curved

Baseplate color in black (RAL 9005) or white (RAL 9010)

Optional extra layer Fabric, Rough, Trevira CS+ | CS, Revive 1, Revive 2, Terra, Clara 2, Remix 2, Hero, Tonus 4, Memory 2 or Matrix

Bicolor (front & back different color)

Wheels (4pcs)

Baseplate curved

S: H 120 cm W 109 cm D 43,5 cm
H 47.24" W 42.91" D 17.13"

M: H 155 cm W 109 cm D 43,5 cm
H 61.02" W 42.91" D 17.13"

L: H 190 cm W 109 cm D 43,5 cm
H 74.80" W 42.91" D 17.13"

+ Wheels: + 3 cm | 1.18"

Fabrics

Felt

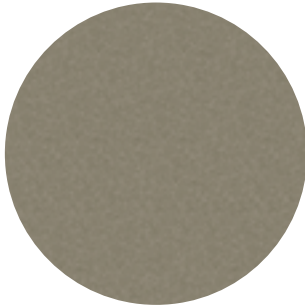

Composition 100% Recycled PE.T. Felt, latex backing
Weight 1.000 g/m² | 29.49 oz/yd²
Abrasion resistance >7.000 Martindale
Flammability EU: EN 13501.1 + A1/2009 Class B-s1,d0
USA: ASTM E84 Class A certified
Fastness to light USA 5



Fabric

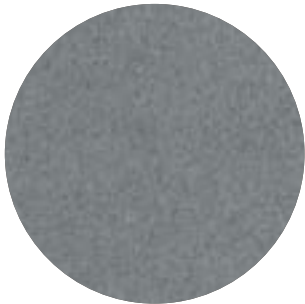

Category A
Composition 70% Recycled Wool, 25% Recycled Polyacryl,
5% Recycled Other Fabrics
Weight 405 g/m² | 11.94 oz/yd²
Abrasion resistance 40.000 Martindale, 50,000 Wyzenbeek
Flammability EU: EN 1021.1/2006 | BS EN 1021.1/2006 (cigarette).
EN 1021.2/2006 | BS EN 1021.2/2006 (match)
USA: CAL TB 117 | ASTM E84 CLASS A
Fastness to light EU: 4 | USA 4
Fastness to rubbing EU: Wet 3-4 | Dry 4-5
Fastness to crocking USA: Wet 5 | Dry 5



Rough



Category A
Composition 100% Polyacryl
Weight 456 g/m² | 13.45 oz/yd²
Abrasion resistance 40.000 Martindale
Flammability EU: EN 1021.1/2006 | BS EN 1021.1/2006 (cigarette)
USA: CAL TB TB 117
Fastness to light EU: 5
Fastness to rubbing EU: Wet: 3 | Dry: 3



Trevira CS+ | CS

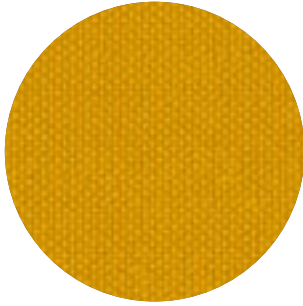

Category A

Weight 420 g/m² | 12.39 oz/yd²

Composition 100% Polyester, Trevira CS

Abrasion resistance 100.000 Martindale, 90,000 Wyzenbeek

Flammability BS 5852 part II: CRIB 5 | BS 7176 Medium Hazard
USA: CAL TB 117 | M1 | B1 | EN 1021/1-2 | C1 |
IMO Res. A652 (16)

Fastness to light EU: 6 | USA 5

Fastness to rubbing EU: Wet 4-5 | Dry 4-5

Fastness to crocking USA: Wet 5 | Dry 5



Revive 1

kvadrat

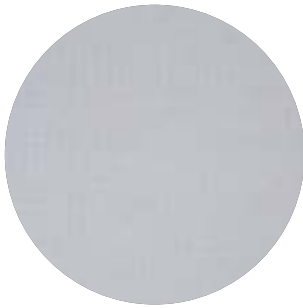

Category A

Composition 100% recycled polyester FR

Weight 430 g/lin.m

Abrasion resistance 60.000 Martindale rubs, EN ISO 12947

Flammability EN 1021-1/2 | DIN 4102 B1 | Önorm B1/Q1
UNI 9175 1IM | US Cal. Tech. Bull. 117
IMO A.652 (16)

Fastness to light Note 5-7, ISO 105-B02

Fastness to rubbing (ISO) dry 5, wet 4-5

Pilling Note 4-5, EN ISO 12945



Revive 2

kvadrat

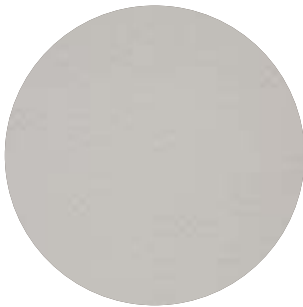

Category A

Composition 100% recycled polyester FR

Weight 420 g/lin.m

Abrasion resistance 45.000 Martindale rubs, EN ISO 12947

Flammability EN 1021-1/2 | DIN 4102 B1 | Önorm B1/Q1
UNI 9175 1IM | US Cal. Tech. Bull. 117
IMO A.652 (16)

Fastness to light Note 5-7, ISO 105-B02

Fastness to rubbing (ISO) dry 5, wet 4-5

Pilling Note 4-5, EN ISO 12945



Terra



Category B

Composition 100% Pure New Wool

Weight 370 g/m² | 10.91 oz/yd²

Abrasion resistance 40.000 Martindale, 25,000 Wyzenbeek

Flammability EU: BS5852 CRIB 5 | BS5867 PART 2 : 2008 : TYPE B
EN: 1021.2/2006 | USA: CAL TB 117

Fastness to light EU 5 | USA 5

Fastness to rubbing EU: Wet 4 | Dry 4

Fastness to crocking USA: Wet 4 | Dry 4



Clara 2

kvadrat

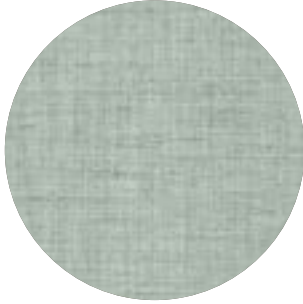

Category B

Composition 92% new wool, 8% nylon

Weight 400 g/lin.m

Abrasion resistance 80.000 Martindale rubs, EN ISO 12947

Flammability EN 1021-1/2 | BS 5852, ignition source 2-3 | DIN 4102 B2
NF D 60 013 | UNI 9175 1IM | US Cal. Tech. Bull. 117, Sec. E
NFPA 260 | IMO A.652(16)

Fastness to light Note 5-7, ISO 105-B02

Fastness to rubbing (ISO) dry 4-5, wet 4

Pilling Note 4, EN ISO 12945



Remix 2

kvadrat

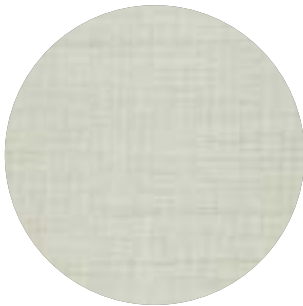

Category B

Composition 90% new wool, 10% nylon

Weight 415 g/lin.m

Abrasion resistance 100.000 Martindale rubs, EN ISO 12947

Flammability EN 1021-1/2 | BS 5852 part 1
Önorm B1/Q1 | NF D 60 013 | UNI 9175, 1IM
AS/NZS 1530.3 | Cal. Tech. Bull. 117-2013
NFPA 260 | IMO FTP Code 2010:Part 8

Fastness to light Note 5-7, ISO 105-B02

Fastness to rubbing (ISO) dry 4-5, wet 4

Pilling Note 4, EN ISO 12945



Hero

kvadrat

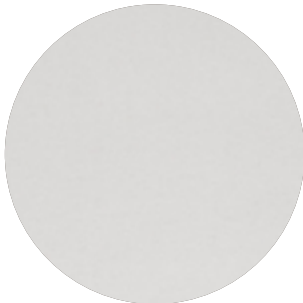

Category C

Composition 96% new wool, 4% nylon

Weight 580 g/lin.m

Abrasion resistance 45.000 Martindale rubs, EN ISO 12947

Flammability EN 1021-1/2 | DIN 4102 B2 | NF D 60 013
UNI 9175 1IM | US Cal. Bull. 117-2013 | NFPA 260
IMO A.652 (16)

Fastness to light Note 5-6, ISO 105-B02

Fastness to rubbing (ISO) dry 4-5, wet 4-5

Pilling Note 3-4, EN ISO 12945



Tonus 4

kvadrat



Category D

Composition 90% new wool, 10% Helanca

Weight 665 g/lin.m

Abrasion resistance 100.000 Martindale rubs, EN ISO 12947

Flammability EN 1021-1/2 | BS 5852 part 1 | DIN 4102 B2
Önorm B1/Q1 | NF D 60 013 | UNI 9175 1IM
US Cal. Bull. 117-2013 | NFPA 260 | IMO A.652 (16)

Fastness to light Note 5-7, ISO 105-B02

Fastness to rubbing (ISO) dry 3-5, wet 3-5

Pilling Note 3, EN ISO 12945



Memory 2

kvadrat

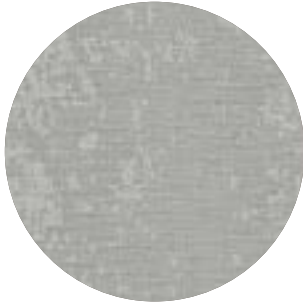

Category E

Composition 100% Trevira CS

Weight 700 g/lin.m

Abrasion resistance

35.000 rubs acc. to the Martindale method, EN ISO 12947

Flammability EN 1021-1/2 | DIN 4102 B1 | Önorm B1/Q1
NF D 60 013 | NF P 92 507 M1 | UNI 9175 1IM
UNI 9177 classe 1 | US Cal. Tech. Bull. 117
IMO A.652 (16)

Fastness to light Note 5-8, ISO 105-B02

Fastness to rubbing (ISO) dry 4-5, wet 4-5

Pilling Note 4, EN ISO 12945



Matrix

kvadrat



Category F

Composition 100% Trevira CS

Weight 760 g/lin.m

Abrasion resistance

App. 60.000 rubs acc. to the Martindale method, EN ISO 12947

Flammability EN 1021-1/2 | BS 5852 crib 5 | BS 5867 part 2 type B
DIN 4102 B1 | Önorm B1/Q1 | NF D 60 013
UNI 9175 1IM | US Cal. Tech. Bull. 117 | NFPA 701
IMO A.652 (16)

Fastness to light Note 5-7, ISO 105-B02

Fastness to rubbing (ISO) dry 4-5, wet 4-5

Pilling Note 4, EN ISO 12945



Felt Printed

Composition 100% Recycled P.E.T. Felt, latex backing

Weight 1.000 g/m² | 29.49 oz/yd²

Abrasion resistance >7.000 Martindale

Flammability EU: EN 13501.1 + A1/2009 Class B-s1,d0

USA: ASTM E84 Class A certified

Fastness to light USA 5



Concrete



Green 1



Green 2



Jungle



Marble Absynth



Marble Emperador



Camo Amazon



Camo Taiga



Camo Desert



Camo Snow

Dimensions

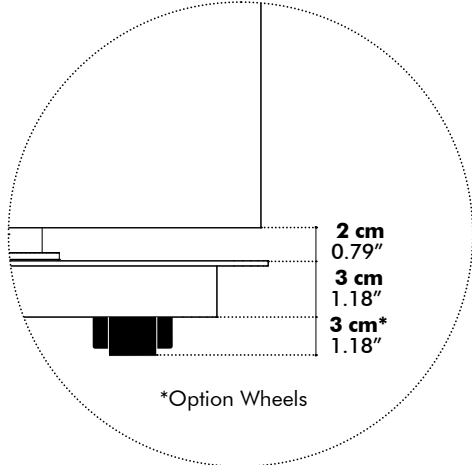
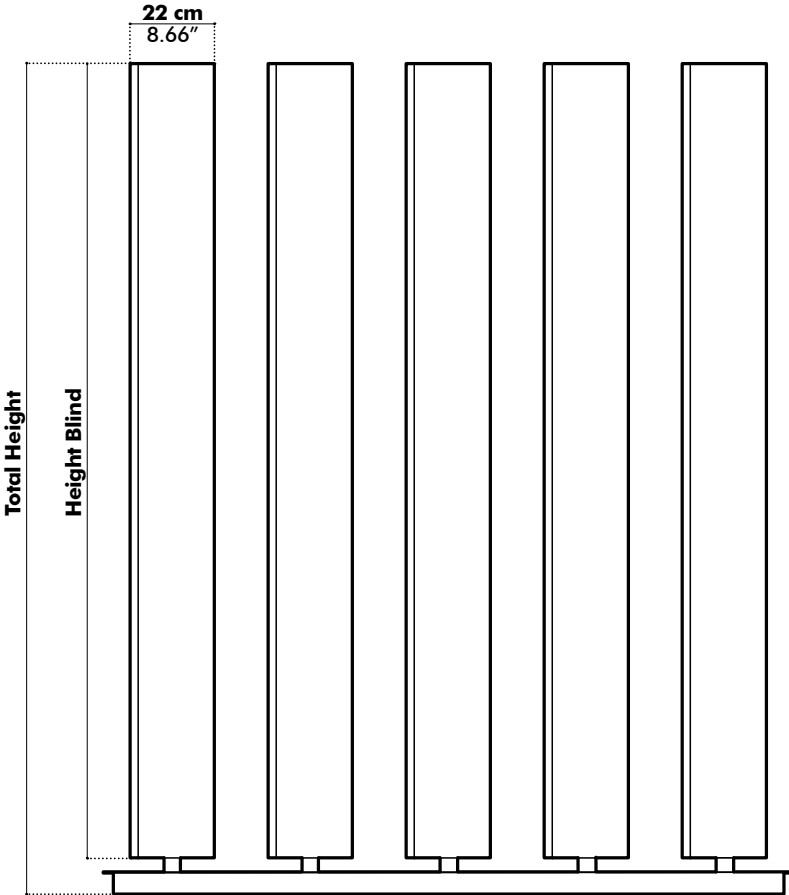

	Height Blind		Total Height	
S	115 cm	45.28"	120 cm	47.24"
M	150 cm	59.06"	155 cm	61.02"
L	185 cm	72.83"	190 cm	74.80"

Regular

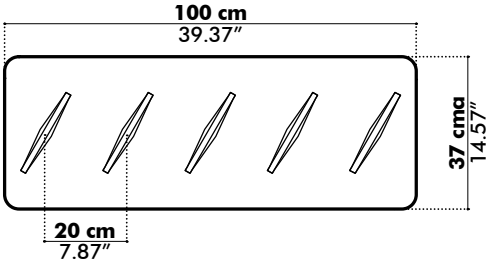

Curved

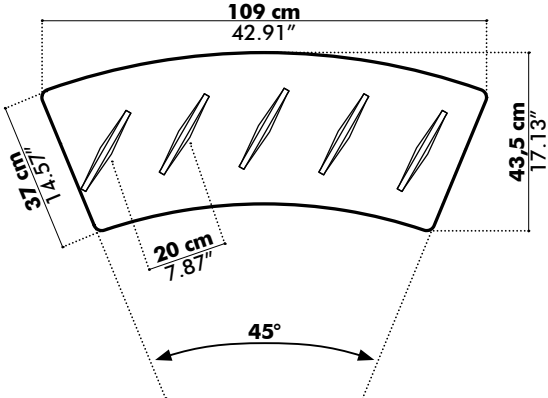

Acoustics

Equivalent sound absorption area in m² per object

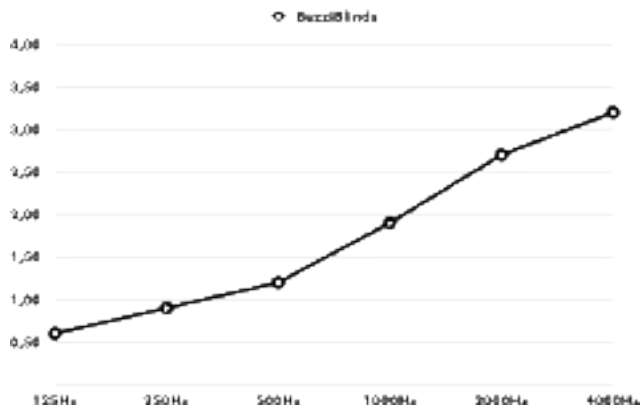

Hz	Aeq/m ²
125	0.6
250	0.9
500	1.2
1000	1.9
2000	2.7
4000	3.2