

# BuzziTotem

INSTALLATION MANUAL

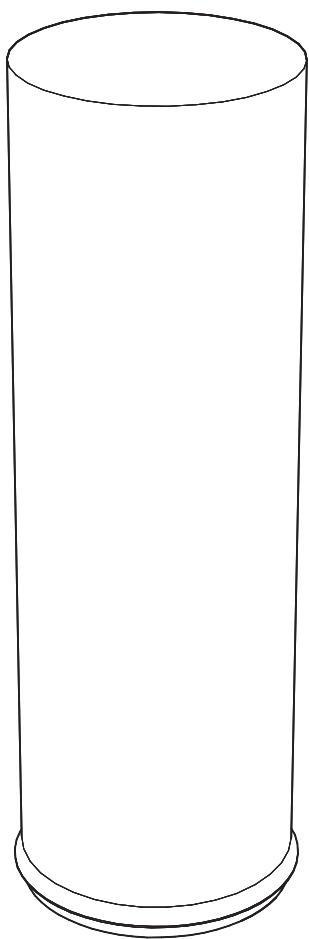

**Incl. BuzziTotem Wedge**

---

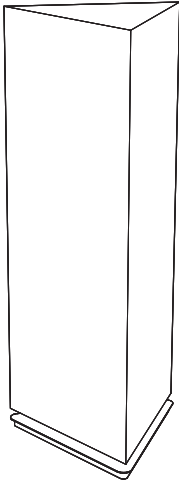

**Incl. BuzziTotem Beam**

---

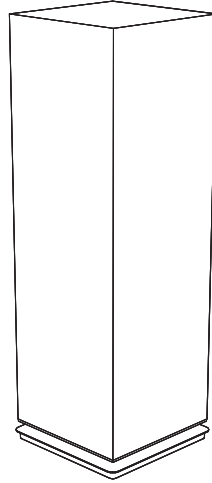

**Incl. BuzziTotem Cylinder**

---

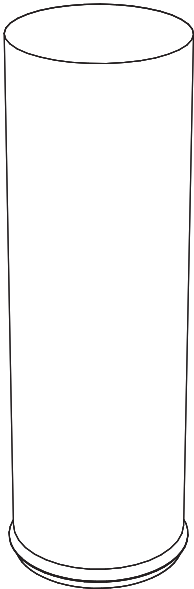

**Optional Wheels**

---

Wedge 3x  
Beam 4x  
Cylinder 5x



Wedge 3x  
Beam 4x  
Cylinder 5x

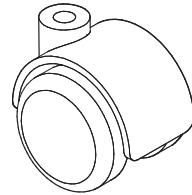

1x

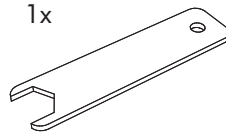

# BuzziTotem

2 PERS. 

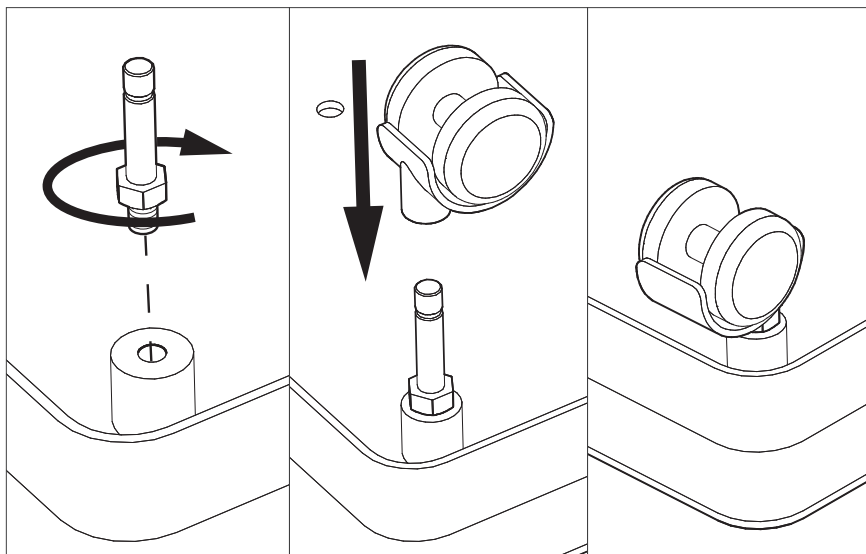
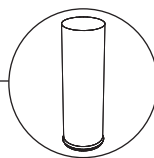

**BuzziSpace**  
Groeningenlei 141  
2550 Antwerp, Kontich  
Belgium  
☎ +32 (0)3 846 10 00  
✉ [info@buzzi.space](mailto:info@buzzi.space)  
🌐 [www.buzzi.space](http://www.buzzi.space)

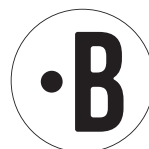

Doc nr.: A-0000003538  
Last update: 02/07/2018